



# MODULUS<sup>®</sup> HOME-THEATER SYSTEM

Owner's Guide



# CAUTION

## RISK OF ELECTRIC SHOCK DO NOT OPEN

WARNING: SHOCK HAZARD, DO NOT OPEN.  
AVIS: RISQUE DE CHOC ELECTRIQUE – NE PAS OUVRIR.  
CUIDADO: PELIGRO DE CHOQUE ELÉCTRICO – NO ABRIR.

CAUTION: TO REDUCE THE RISK OF ELECTRIC SHOCK  
DO NOT REMOVE COVER (OR BACK)  
NO USER SERVICEABLE PARTS INSIDE  
REFER SERVICING TO QUALIFIED PERSONNEL

**THIS INFINITY PRODUCT IS DESIGNED FOR 120-VOLT USE ONLY! FOR DETAILED SAFETY PRECAUTIONS, PLEASE SEE FOLLOWING PAGE IN THIS OWNER'S MANUAL FOR "IMPORTANT SAFETY INSTRUCTIONS."**



*The lightning flash with arrowhead symbol, within an equilateral triangle, is intended to alert the user to the presence of uninsulated "dangerous voltage" within the product's enclosure that may be of sufficient magnitude to constitute a risk of electric shock to persons.*



*The exclamation point within an equilateral triangle is intended to alert the user to the presence of important operating and maintenance (servicing) instructions in the literature accompanying the product.*

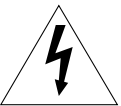

L'éclair avec le symbole de la flèche, placé dans les limites d'un triangle équilatéral est prévu pour avertir l'utilisateur de la présence de "tension dangereuse" non isolée dans l'enceinte du produit qui pourrait être d'une importance suffisante pour présenter un risque d'électrocution aux personnes.



Le point d'exclamation dans un triangle équilatéral est prévu pour avertir l'utilisateur de la présence d'instructions importantes pour les opérations et l'entretien (service) dans les manuels fournis avec l'appareil.

**ATTENTION: POUR EVITER LES CHOCS ELECTRIQUES, INTRODUIRE LA LAME LA PLUS LARGE DE LA FICHE DANS LA BORNE CORRESPONDANTE DE LA PRISE ET POUSSER JUSQU'AU FOND.**



Este destello luminoso con un símbolo de punta de flecha dentro de un triángulo equilátero tiene el objetivo de alertar al usuario sobre la presencia de "voltaje peligroso" no aislado dentro de la caja del producto que puede ser de magnitud lo suficientemente grande para constituir un riesgo de choque eléctrico para las personas.



Este punto de exclamación dentro de un triángulo equilátero tiene el objetivo de alertar al usuario sobre la existencia de instrucciones operativas y de mantenimiento (servicio) importantes en la literatura que acompaña el aparato.

**CUIDADO: PARA REDUCIR EL RIESGO DE CHOQUE ELÉCTRICO, NO RETIRE LA CUBIERTA (O RESPALDO). DENTRO NO HAY PEIZAS A LAS QUE EL USUARIO PUEDE DAR SERVICIO. REMITA EL SERVICIO AL PERSONAL DE SERVICIO CALIFICADO.**

**CAUTION: TO PREVENT ELECTRIC SHOCK, MATCH WIDE BLADE OF PLUG TO WIDE SLOT; FULLY INSERT.**

**WARNING: TO REDUCE THE RISK OF FIRE OR ELECTRIC SHOCK, DO NOT EXPOSE THIS PRODUCT TO RAIN OR MOISTURE.**

# IMPORTANT SAFETY PRECAUTIONS

## Read First!

**CAUTION**  
**RISK OF ELECTRIC SHOCK**  
**DO NOT OPEN**

CAUTION: To prevent electric shock, do not remove the grounding plug on the power cord, or use any plug or extension cord that does not have a grounding plug provided. Make certain that the AC outlet is properly grounded. Do not use an adapter plug with this product.

 The lightning flash with arrowhead symbol, within an equilateral triangle, is intended to alert the user to the presence of uninsulated "dangerous voltage" within the product's enclosure that may be of sufficient magnitude to constitute a risk of electric shock to persons.

 The exclamation point within an equilateral triangle is intended to alert the user to the presence of important operating and maintenance (servicing) instructions in the literature accompanying the appliance.

1. **Read Instructions.** All the safety and operating instructions should be read before the product is operated.
2. **Retain Instructions.** The safety and operating instructions should be retained for future reference.
3. **Heed Warnings.** All warnings on the product and in the operating instructions should be adhered to.
4. **Follow Instructions.** All operating and use instructions should be followed.
5. **Cleaning.** Unplug this product from the wall outlet before cleaning. Do not use liquid cleaners or aerosol cleaners. Use a damp cloth for cleaning.
6. **Attachments.** Do not use attachments not recommended by the product manufacturer, as they may cause hazards.
7. **Water and Moisture.** To reduce the risk of fire or electric shock, do not use this product outdoors or near water—for example, near a bathtub, wash bowl, kitchen sink or laundry tub; in a wet basement; near a swimming pool; or the like.
8. **Accessories.** Do not place this product on an unstable cart, stand, tripod, bracket or table. The product may fall, causing serious injury to a child or adult, and serious damage to the product. Use only with a cart, stand, tripod, bracket or table recommended by the manufacturer, or sold with the product. Any mounting of the product should follow the manufacturer's instructions, and should use a mounting accessory recommended by the manufacturer.
9. **A Product and Cart Combination Should Be Moved with Care.** Quick stops, excessive force and uneven surfaces may cause the product and cart combination to overturn. 
10. **Ventilation.** Slots and openings in the cabinet are provided for ventilation and to ensure reliable operation of the product and to protect it from overheating, and these openings must not be blocked or covered. The openings should never be blocked by placing the product on a bed, sofa, rug or other similar surface. This product should not be placed in a built-in installation, such as a bookcase or rack,

unless proper ventilation is provided or the manufacturer's instructions have been adhered to.

11. **Power Sources.** This product should be operated only from the type of power source indicated on the marking label. If you are not sure of the type of power supply to your home, consult your product dealer or local power company. For products intended to operate from battery power, or other sources, refer to the operating instructions.

12. **Grounding or Polarization.** This product may be equipped with a polarized alternating-current-line plug (a plug having one blade wider than the other). This plug will fit into the power outlet only one way. This is a safety feature. If you are unable to insert the plug fully into the outlet, try reversing the plug. If the plug should still fail to fit, contact your electrician to replace your obsolete outlet. Do not defeat the safety purpose of the polarized plug.

13. **Power-Cord Protection.** Power-supply cords should be routed so that they are not likely to be walked on or pinched by items placed upon or against them, paying particular attention to cords at plugs, convenience receptacles, and the point where they exit from the product.

14. **Nonuse Periods.** The power cord of the product should be unplugged from the outlet when left unused for long periods of time.

15. **Outdoor Antenna Grounding.** If an outside antenna or cable system is connected to the product, be sure the antenna or cable system is grounded so as to provide some protection against voltage surges and built-up static charges. Article 810 of the National Electrical Code, ANSI/NFPA 70, provides information with regard to proper grounding of the mast and supporting structure, grounding of the lead-in wire to an antenna discharge unit, size of grounding conductors, location of antenna-discharge unit, connection to grounding electrodes, and requirements for the grounding electrode. See Figure A.

16. **Lightning.** For added protection for this product during a lightning storm, or when it is left unattended and unused for long periods of time, unplug it from the wall outlet and disconnect the antenna or cable system. This will prevent damage to the product due to lightning and power-line surges.

17. **Power Lines.** An outside antenna system should not be located in the vicinity of overhead power lines or other electric light or power circuits, or where it can fall into such power lines or circuits. When installing an outside antenna system, extreme care should be

taken to keep from touching such power lines or circuits, as contact with them might be fatal.

18. **Overloading.** Do not overload wall outlets, extension cords, or integral convenience receptacles, as this can result in a risk of fire or electric shock.

19. **Object and Liquid Entry.** Never push objects of any kind into this product through openings, as they may touch dangerous voltage points or short-out parts that could result in a fire or electric shock. Never spill liquid of any kind on the product.

20. **Servicing.** Do not attempt to service this product yourself, as opening or removing covers may expose you to dangerous voltage or other hazards. Refer all servicing to qualified service personnel.

21. **Damage Requiring Service.** Unplug this product from the wall outlet and refer servicing to qualified service personnel under the following conditions:

- a. The power-supply cord or the plug has been damaged; or
- b. Objects have fallen onto, or liquid has been spilled into, the product; or
- c. The product has been exposed to rain or water; or
- d. The product does not operate normally when following the operating instructions. Adjust only those controls that are covered by the operating instructions, as an improper adjustment of other controls may result in damage and will often require extensive work by a qualified technician to restore the product to its normal operation; or
- e. The product has been dropped or damaged in any way; or
- f. The product exhibits a distinct change in performance; this indicates a need for service.

22. **Replacement Parts.** When replacement parts are required, be sure the service technician has used replacement parts specified by the manufacturer or that have the same characteristics as the original part. Unauthorized substitutions may result in fire, electric shock or other hazards.

23. **Safety Check.** Upon completion of any service or repairs to this product, ask the service technician to perform safety checks to determine that the product is in proper operating condition.

24. **Wall or Ceiling Mounting.** The product should be mounted to a wall or ceiling only as recommended by the manufacturer.

25. **Heat.** The product should be situated away from heat sources such as radiators, heat registers, stoves or other products (including amplifiers) that produce heat.

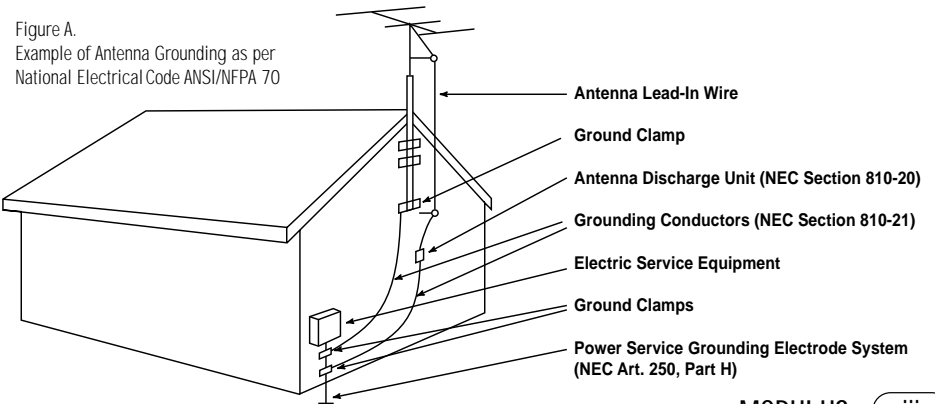

# MODULUS HOME-THEATER SYSTEM OWNER'S GUIDE

## Table of Contents

ii	Caution
iii	Important Safety Precautions
1	Introduction
1	Technology
1	Ceramic Metal Matrix Diaphragms™ (C.M.M.D.)
1	Amplifier
1	Room-Friendly Acoustical Design
2	Unpacking the System
3	Planning Your System
3	Placement
6	Center and Satellite Speaker Connections
7	Subwoofer Controls
8	Subwoofer Connections
9	Operation
10	Room Adaptive Bass Optimization System™ (R.A.B.O.S.)
11	Contents of the R.A.B.O.S. Test CD
11	R.A.B.O.S. Sound-Level Meter (RSLM)
16	What You Measure, What To Do
19	Adjusting the R.A.B.O.S. Equalizer
20	Final System Balance
20	Maintenance and Service
21	Specifications
22	R.A.B.O.S. Measurement Templates

## INTRODUCTION

The Infinity Modulus Home-Theater System is a compact, efficient, universal satellite, center-channel and subwoofer system that is ideal for reproducing home-theater sound. With their versatile design, the satellite speakers can be placed virtually anywhere on shelves or stands, or mounted on a wall or ceiling using the supplied base. The center channel can easily be placed on top of, or on a shelf below, the television. The powered subwoofer delivers tremendous bass performance from a compact, easy-to-place design.

### About This Manual

To start enjoying your new Modulus Home-Theater System, read and then follow all instructions listed in this guide, as well as those found in the owner's manuals of associated components in your audio system. Save all instructions for future reference.

## TECHNOLOGY

Modulus loudspeakers incorporate several innovative technologies that, when implemented by our exceptionally talented engineers after hours upon hours of subjective listening evaluations, result in a loudspeaker that realistically and accurately reproduces the signal source with minimal distortion and coloration.

### Ceramic Metal Matrix Diaphragms™ (C.M.M.D.)

For decades, loudspeaker engineers have known that the ideal transducer should be stiff, yet light, and have high internal damping (damping is a material's ability to absorb energy). Infinity's C.M.M.D. transducer is a significant advance in transducer technology. Ceramic, a class of material new to loudspeakers, offers better performance than other materials. Ceramic is stiffer than metals and lighter than plastics and typical composite materials; it also offers improved damping. These ceramic-based transducers take us a giant step closer to the ever-elusive "ideal transducer."

In tweeters, C.M.M.D. technology offers stiffness and damping superior to that of traditional metals and soft-dome materials. In woofer and midrange applications, it offers accurate pistonic operation over the entire frequency range of the driver, completely eliminating coloration due to cone breakup and dramatically reducing distortion. And when ceramic-metal-matrix transducers are exposed to moisture, sunlight or extreme temperatures, their performance does not deteriorate.

In addition to ceramic diaphragms, all the transducers incorporate magnetic shielding and rigid cast-frames that, through our FEA computer modeling and scanning-laser-vibrometer measurements, have been optimized to reduce resonances. This ensures minimal distortion and incomparable performance.

### Amplifier

BASH® is an amplifier-power-supply technology that increases efficiency by reducing power dissipation in the output section. The BASH topology uses a high-efficiency, fast-response, switch-mode power supply that provides the main voltage rails for a linear Class-AB amplifier. By varying the output of the power supply with the audio signal being amplified, a constant voltage drop across the output transistors of the linear amplifier can be maintained. This means that the power dissipation in the output transistors is greatly reduced.

The result is an extremely efficient audio amplifier that does not compromise audio performance.

### Room-Friendly Acoustical Design

Driver quality is not the only requirement for exceptional performance. Infinity's engineers understand that the room in which the loudspeaker is placed can greatly affect its performance. To ensure that Modulus loudspeakers will sound exceptional in even the most unexceptional listening environment, Infinity has developed the proprietary Room Adaptive Bass Optimization System™ (R.A.B.O.S.). With a single band of parametric equalization, the Modulus subwoofer can be adjusted to tame any problematic room-bass resonances below 80Hz.

We hope you enjoyed this brief introduction to the technology featured in the Modulus Home-Theater System. If you would like to further explore Modulus' technology and design, please ask your Infinity dealer for the C.M.M.D. and R.A.B.O.S. White Papers. The White Papers can also be downloaded from Infinity's Web site at [www.infinitysystems.com](http://www.infinitysystems.com).

## Unpacking the System

Carefully unpack the system. If you suspect damage from transit, report it immediately to your dealer and/or delivery service. Keep the shipping carton and packing materials for future use. Open the package and verify the following contents:

- (1) Modulus Powered Subwoofer

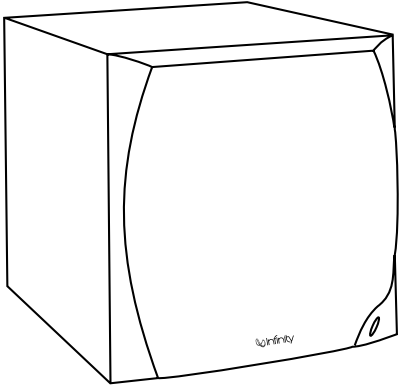

- (1) A/C Power Cord



- (1) Modulus Center-Channel Speaker

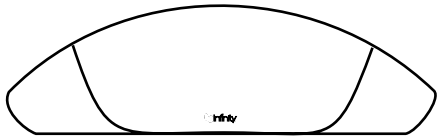

- (4) Modulus Satellite Speakers with Attached Base

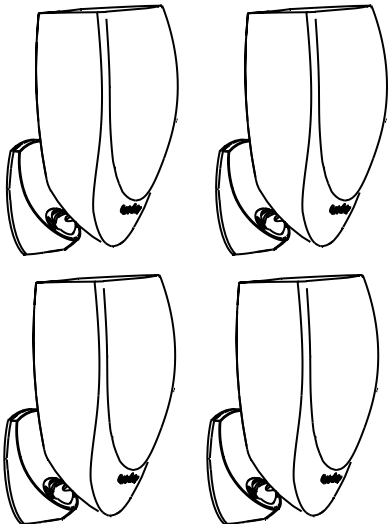

- (4) Modulus Wall-Mount Brackets (attached to Base of Satellites)

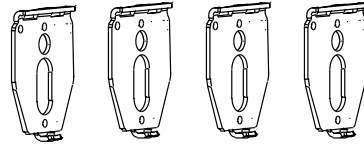

- (1) Wall-Mount Bracket With Bubble Level for Use as Mounting Template.

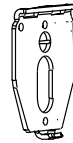

- (1) R.A.B.O.S. Kit

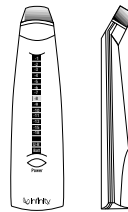

Sound-Level Meter



R.A.B.O.S. Test CD

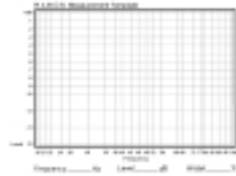

Graph Templates

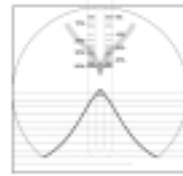

Bandwidth Selector

Adjustment Key

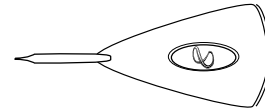

- Hex Wrench (Located Behind Rubber Cap of Satellite Base) 
- Warranty Statement

To prevent fire or shock hazard, DO NOT EXPOSE THIS SYSTEM TO RAIN OR EXCESSIVE MOISTURE. To avoid electric shock, DO NOT OPEN THE ENCLOSURES! There are no user-serviceable parts inside. Observe all warnings and cautions.

## PLANNING YOUR SYSTEM

Before deciding where to best place your speakers, survey your room and study Figure 1.

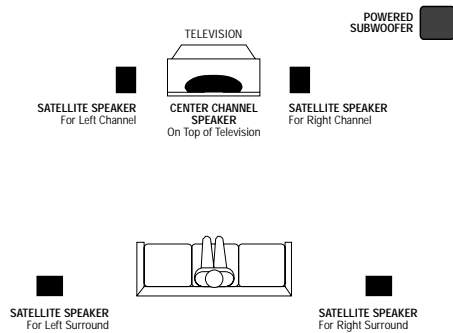

**FIGURE 1** – In this overhead view of a typical installation, satellite speakers are used to reproduce sound for the front and surround channels. The center channel reproduces sound and dialog. The powered subwoofer provides bass for effects and music.

## PLACEMENT

**NOTE:** The satellite speakers can be placed directly on a shelf, or mounted on a wall using the built-in base/bracket.

### Front Left and Right Channels

For front left and right channels, place one satellite to the left and another to the right of the television, as shown in Figure 1. Since the speakers are magnetically shielded, you can place them very close to the TV without worrying about the magnetic field distorting the picture.

### Center Channel

For the center channel, place the speaker directly on top of, or below, your television. Use a shelf if the television does not provide a stable platform.

### Surround Channels

For surround left and right channels, place one speaker on the left and another on the right, to the side of or behind the listening area.

### Subwoofer

Since the installation of a subwoofer can be somewhat more complicated than installing full-range speakers, it is essential that you read this section very carefully prior to connecting the subwoofer to your system. Should you have questions relating to installation, it is advisable to call either your dealer or Infinity's Customer Service Department for advice.

The performance of the subwoofer is directly related to its placement in the listening room and how you align the subwoofer with the satellite speakers. Setting the volume of the subwoofer in relation to the left and right speakers is also of critical importance because it is essential that the subwoofer integrate smoothly with the entire system. Setting the subwoofer's volume level too high will result in an overpowering, boomy bass. Setting the volume level too low will negate the benefits of the subwoofer.

Here are several additional facts on installation that may prove useful. It is generally believed that low frequencies (below 125Hz) are nondirectional and, therefore, placement of a subwoofer within any listening room is not critical. While in theory it is true that the larger wavelengths of extremely low frequencies are basically nondirectional, the fact is that, when installing a subwoofer within the limited confines of a room, reflections, standing waves and absorptions generated within the room will strongly influence the performance of any subwoofer system. As a result, specific location of the subwoofer becomes important, and we strongly recommend that you experiment with placement before choosing a final location. Placement will depend upon your room (for example, whether or not your room permits placement of the subwoofer near either satellite) and the amount and quality of bass required.

The R.A.B.O.S. guide, which begins on page 10, will also assist you in optimizing bass response for your room.

# INSTALLING THE SATELLITES

## For Shelf Placement

1. Remove the Modulus satellites from the box. Remove rubber cover from the base and pull out Allen wrench.

FIGURE 2

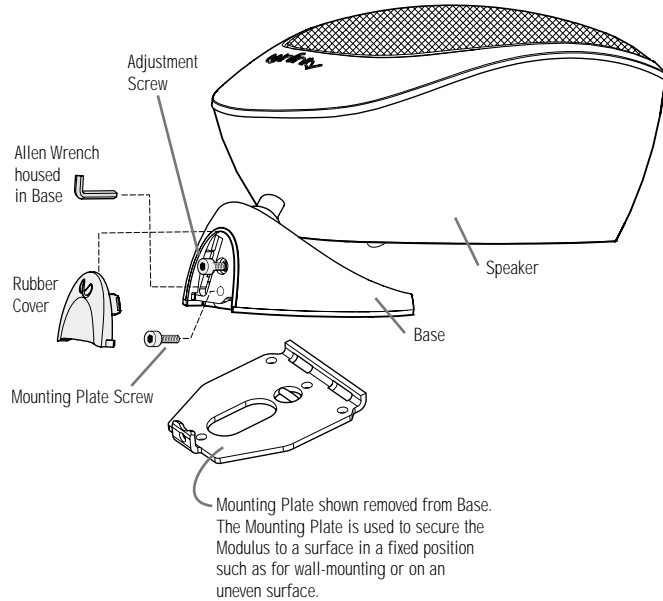

2. Use the Allen wrench to loosen the adjustment screw (as necessary) to allow the mounting ball on the speaker to turn freely in the cup restraint.

FIGURE 3

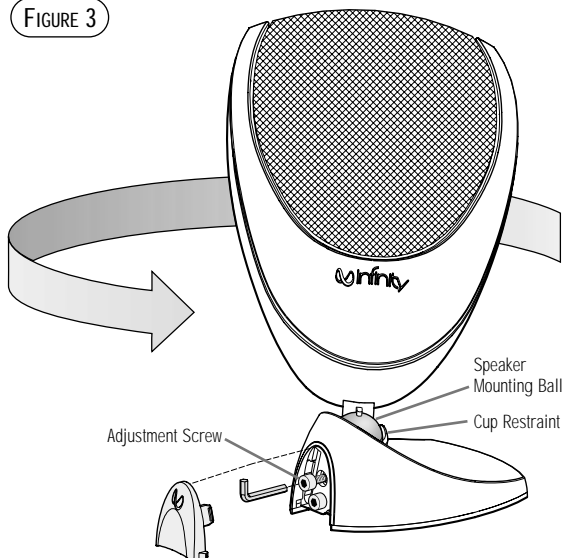

3. Run the speaker wires in through the rear of the base and up through the speaker wire holes on the left and right sides of the cup restraint (see page 6, Figure 9 for wire connections).

FIGURE 4

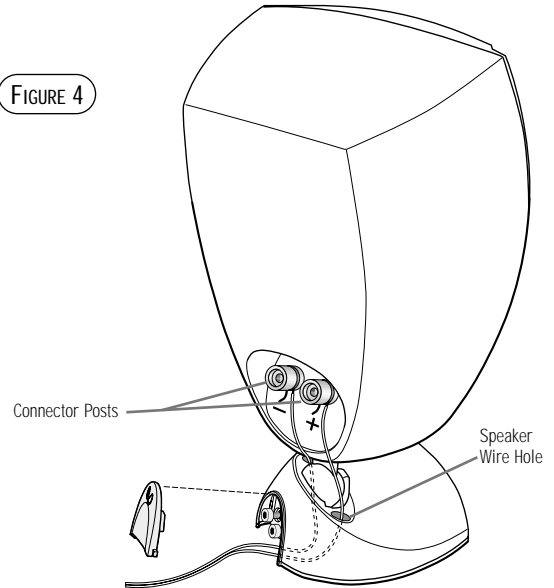

4. Rotate speaker on its base into the shelf placement position as shown below. Tighten the adjustment screw with the Allen wrench (securing the speaker in position) and replace the cover.

FIGURE 5

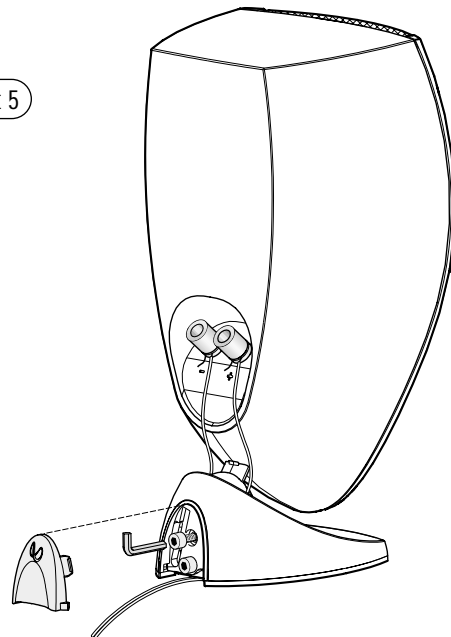



## For Wall-Mounting

*Note: The customer is responsible for the correct selection and use of mounting hardware (available through hardware stores) that will ensure the proper and safe wall-mounting of the speakers.*

1. Remove the Modulus from its box. Remove rubber cover from the base and pull out Allen wrench. Use Allen wrench to remove mounting plate screw and remove mounting plate from base.

FIGURE 6

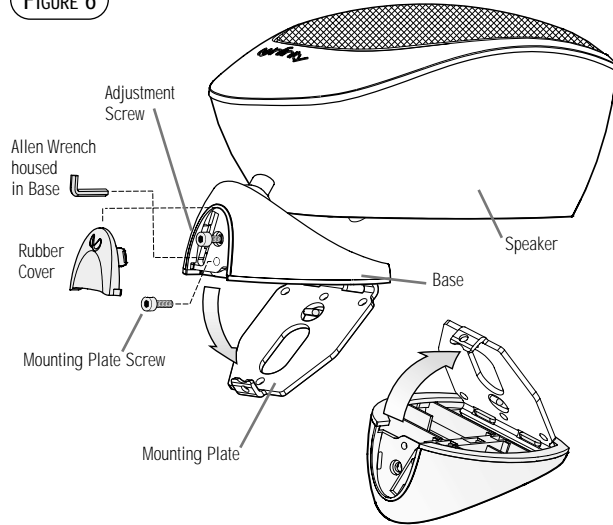

2. Secure the mounting plate to a wall stud using (4) #8-32 wood screws with a minimum 1-1/4" length. If fastened to sheetrock or wallboard with a minimum 1/2" depth, use #8 screws with plastic inserts or anchors. Do not mount directly to sheetrock or wallboard without plastic inserts or anchors designed for #8 screws. One of the mounting plates in the Modulus system has a built-in bubble level for leveling while securing to the wall. This mounting plate should be used as a template for mounting the mounting plates that do not include a bubble level.

2a. In cases where you would like to run the speaker wires through the wall, the mounting plate has a center hole for wire access.

FIGURE 7

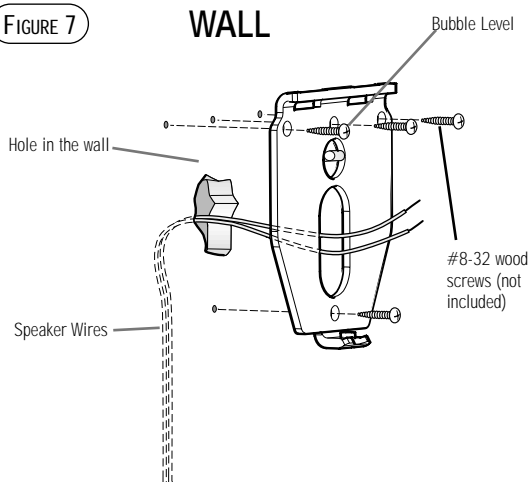

3. Run the speaker wires through the base as shown below. Attach base to mounting plate by slipping the returns on underside of base into slots on the top of the mounting plate and hinging the base downward. Secure base by inserting and tightening mounting plate screw. Tighten adjustment screw,

FIGURE 8

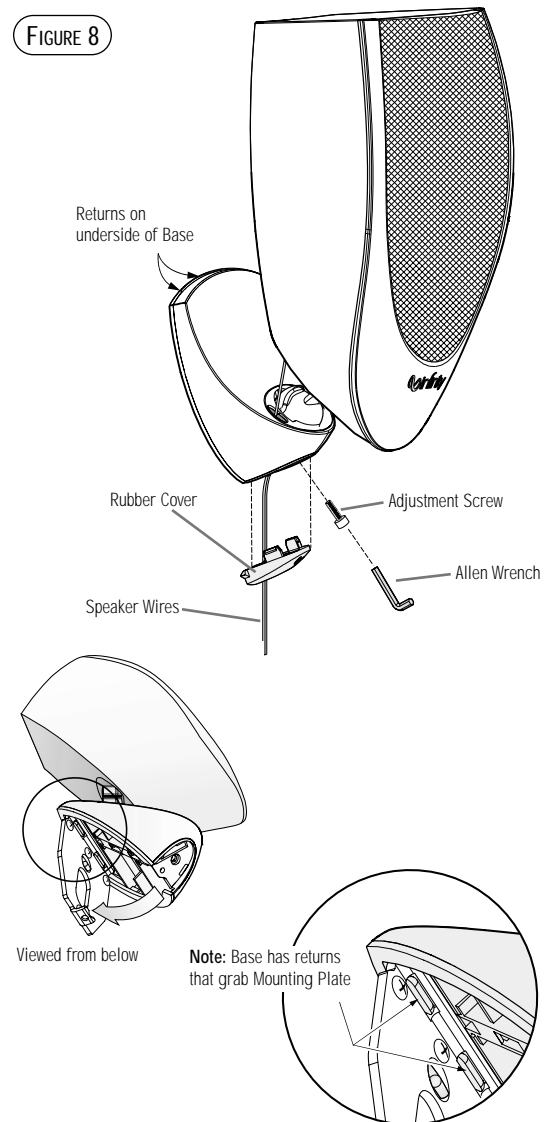

4. Insert the Allen wrench back into holder in base and attach rubber cover.

# CENTER AND SATELLITE SPEAKER CONNECTIONS

## Turn Off All Power

After placing the speakers, you are ready to connect your system. First, turn off all audio-system power. Use high-quality speaker wire to make your connections. Use at least #16-gauge speaker wire with polarity coding. The side of the wire with a ridge or other coding is usually considered positive polarity (i.e., +). Also, consult the owner's manuals that were included with your amplifier or receiver to confirm connection procedures.

## Satellites

Observe polarities when making speaker connections, as shown in Figure 9. Connect each + terminal on the back of the amplifier or receiver to the respective + (red) terminal on each speaker. Connect the – (black) terminals in the same way.

## Important!

Do not reverse polarities (i.e., + to – or – to +) when making connections. Doing so will cause poor imaging and diminished bass response. Be certain that positive and negative wire strands are completely isolated to avoid short circuits that may damage your equipment.

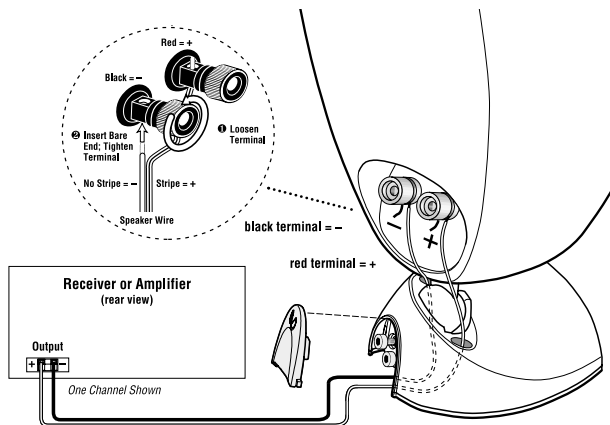

**FIGURE 9** – Wiring diagram shows polarity connections for one channel of a home-theater system.

## Center Channel

Observe polarities when making speaker connections, as shown in Figure 9. Connect each + terminal on the back of the amplifier or receiver to the respective + (red) terminal on the speaker. Connect the – (black) terminals in the same way.

## Important!

Do not reverse polarities (i.e., + to – or – to +) when making connections. Be certain that positive and negative wire strands are completely isolated to avoid short circuits that may damage your equipment.

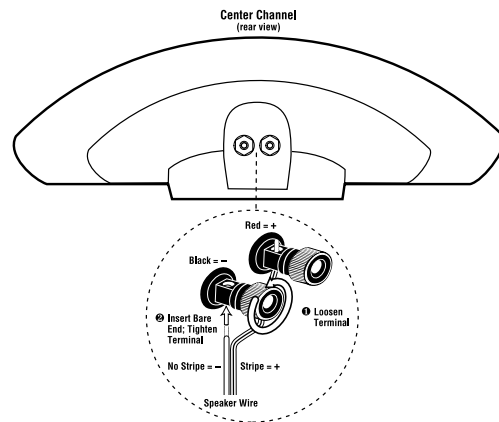

**FIGURE 10** – The satellites and center-channel speaker feature terminals that can be connected in several different ways; e.g., banana plugs, spade terminals and direct wiring (as shown here).

# SUBWOOFER CONTROLS

## Rear Panel

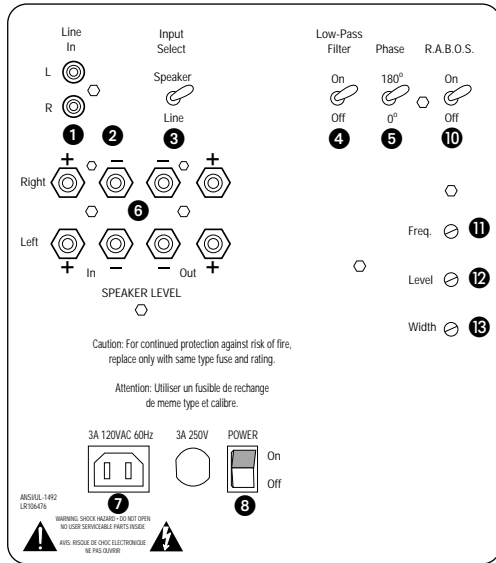

## Front Panel



- ❶ Line-Level Inputs
- ❷ Line-Level Outputs
- ❸ Input Selector
- ❹ Low-Pass Filter Selector
- ❺ Phase Switch
- ❻ Speaker-Level Connectors
- ❼ AC Cord Input
- ❽ Power Switch
- ❾ Subwoofer Gain Control

## Room Adaptive Bass Optimization System Controls (R.A.B.O.S.)

- ❿ R.A.B.O.S. On/Off Switch
- ⓫ Center-Frequency Adjustment
- ⓬ R.A.B.O.S. Level
- ⓭ Bandwidth Adjustment

## A Few Suggestions

We recommend that you do not operate your speakers or subwoofer with the bass, treble and loudness controls set to full boost. This will place undue strain on your electronics and speakers and could damage them.

The volume control setting on your processor/preamp or receiver is not a specific indication of the overall loudness level of the speakers. The only important consideration is the loudness level at which the system can be played, regardless of where the volume control is set.

Always turn down the volume control setting on your processor/preamp or receiver when changing a cassette or CD, or switching inputs to AM or FM operation. Excessively loud transients (clicks or popping sounds) can damage the satellite speakers and possibly the subwoofer.

## Important!

Whenever changing cables, pulling plugs, etc., ALWAYS TURN OFF ALL EQUIPMENT, including the subwoofer. This prevents transients from entering the speakers and prevents electrical energy from reaching you. Keep all connections out of the reach of children.

# SUBWOOFER CONNECTIONS

If your receiver/processor does not have subwoofer outputs for the left and right channels or an LFE output:

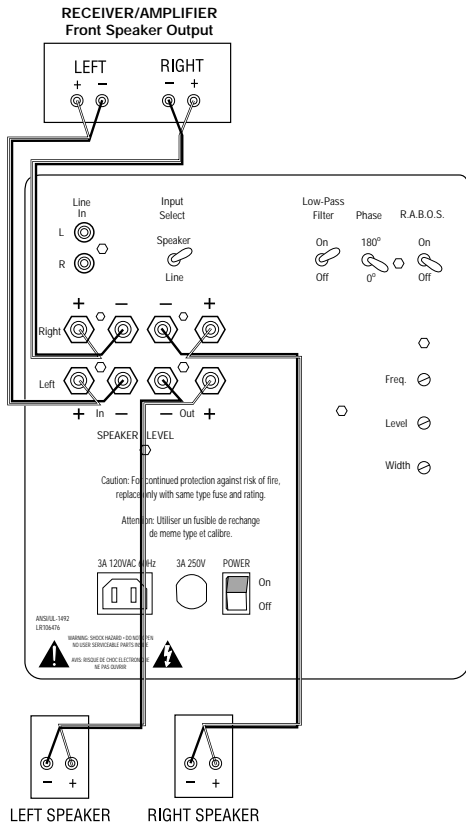

- Set Input Selector to "Speaker."
- Set Low-Pass Filter to "On"

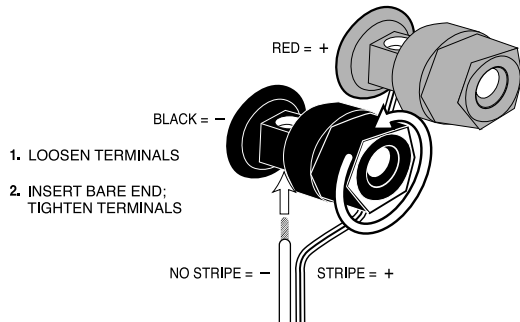

If your receiver/processor has subwoofer outputs for the left and right channels:

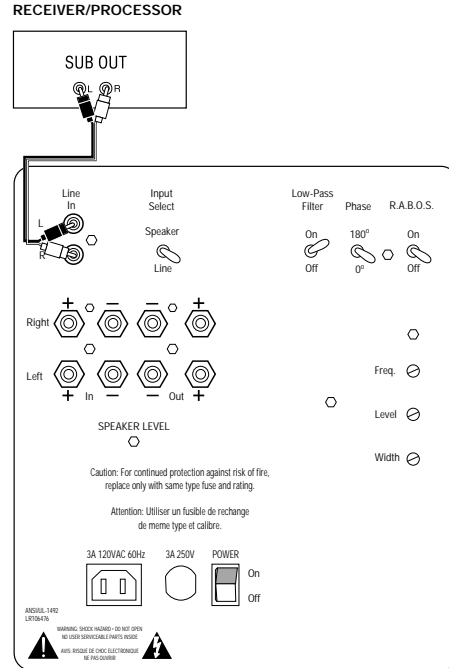

- Set Input Selector to "Line."
- Set Low-Pass Filter to "On."

If you have a Dolby<sup>®</sup> Digital or DTS<sup>®</sup> receiver/processor with a low-frequency-effect (LFE) output:

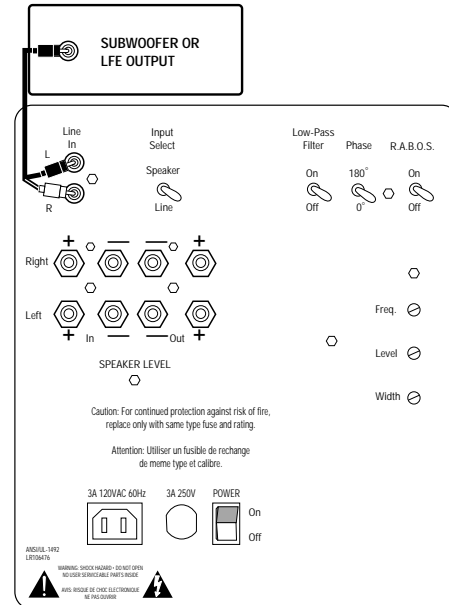

- Set Input Selector to "Line."
- Set Low-Pass Filter to "Off"

Note: Some receivers have a single subwoofer output. In that case, it is recommended that you use a Y connector (not included) to maximize performance.

# OPERATION

## Surround Modes

When using the Modulus system in a Dolby\* Pro Logic\* home-theater system, make sure the receiver's center-channel mode is set to "Normal". When using the Modulus system in a Dolby Digital or DTS home-theater system, make sure the receiver's speaker modes are set to "Small".

Some Dolby Digital-equipped receivers/processors offer different setup options for each source or surround mode: e.g., CD-stereo, videotape, Dolby, Pro Logic. In each case, follow your equipment's instructions to ensure that the subwoofer output is turned on and that the speakers are set to "Small" in each mode.

## Power On

Plug your Modulus subwoofer's AC cord into a wall outlet. Do not use the outlets on the back of the receiver.

Initially set the subwoofer's Gain Control **9** to the "0" position.

Turn on your sub by flipping the Power Switch **8** on the rear panel to the ON position.

## Auto On/Standby

With the Power Switch **8** in the ON position, the Gain Control **9** on the front panel will remain backlit in red or green to indicate the On/Standby mode of the subwoofer.

RED = STANDBY (No signal detected, Amp Off)

GREEN = ON (Signal detected, Amp On)

The subwoofer will automatically enter the Standby mode after approximately 10 minutes when no signal is detected from your system. The subwoofer will then power ON instantly when a signal is detected. During periods of normal use the Power Switch **8** can be left on. You may turn off the Power Switch **8** during extended periods of non-operation: e.g., when you are away on vacation.

## Adjust Gain

Turn on your entire audio system and start a CD or movie soundtrack at a moderate level. Turn your subwoofer's Gain Control **9** up to the "5" position (half way). If no sound emanates from the subwoofer, check the AC-line cord and input cables. Are the connectors on the cables making proper contact? Is the AC plug connected to a "live" receptacle? Has the Power Button **8** been pressed to the "On" position? (Note: The Gain Control **9** on the front panel will turn green when the power is on.) Once you have confirmed that the subwoofer is active, proceed by playing a sound source. Use a selection that has ample bass information.

Set the overall volume control of the preamplifier or stereo to a comfortable level. Adjust the subwoofer's Gain Control **9** until you obtain a pleasing blend of bass. Bass response should not overpower the room but rather be adjusted so there is a harmonious blend across the entire musical range. Many users have a tendency to set the subwoofer volume too loud, adhering to the belief that a subwoofer is there to produce lots of bass. This is not entirely true. A subwoofer is there to enhance bass, extending the response of the entire system so the bass can be felt as well as heard. However, overall balance must be maintained or the music will not sound natural. An experienced listener will set the volume of the subwoofer so its impact on bass response is always there but is never obtrusive.

## Phase Control

The Phase Switch **5** determines whether the subwoofer speaker's piston-like action moves in and out with the main speakers, 0°, or opposite the main speakers, 180°. Proper phase adjustment depends on several variables such as room size, subwoofer placement and listener position. Adjust the phase switch to maximize bass output at the listening position.

## Final Positioning

After correctly connecting the Modulus system and verifying that both the subwoofer and all satellite speakers are playing, it is time to optimize the system for your particular listening room. Earlier, you placed the subwoofer in its general location. Finding the exact location for optimum performance sometimes only involves moving the speakers up to a few inches in any direction. We urge you, therefore, to experiment with placement, if possible, until your speakers deliver their full potential.

# ROOM ADAPTIVE BASS OPTIMIZATION SYSTEM

Infinity R.A.B.O.S. is a simple-to-use, yet sophisticated, low-frequency calibration system. It is designed to work in conjunction with the Infinity Modulus self-amplified subwoofer. The Modulus subwoofer contains a parametric equalizer that you will adjust as indicated by the R.A.B.O.S. test results. Following these instructions, you will optimize the Modulus subwoofer's response characteristics to complement its environment. This will dramatically improve the sound of your system. The optimization process takes less than 30 minutes.

## The R.A.B.O.S. Kit Includes the Following Components:

- Specialized Sound-Level Meter
- Test CD
- Instructions
- Measurement Templates
- Width Selector
- Adjustment "Key"

## What R.A.B.O.S. Does

The Test CD provides specially designed signals you will use while performing measurements. The sound-level meter provided is used to "acquire" the information needed for adjustments. You will create a response plot on the Measurement Template. Using the Width Selector, you will then determine the appropriate equalizer settings. The "Key" is used to adjust the parametric equalizer built into the Modulus subwoofer. After adjustment, the test sequence is repeated to confirm your settings.

## The R.A.B.O.S. Goal

It is a fact of audio that what we hear at low frequencies is determined as much or more by the listening room than by the loudspeaker itself. Placement of the loudspeakers and listeners and the acoustical characteristics of the room surfaces are all important determinants of bass quantity and quality. In most practical situations, there is little that can be done about this, except for patient trial-and-error repositioning of the loudspeakers and listeners. Usually, the practical constraints of a living space and the impracticality of massive acoustical treatment mean that equalization is the only practical solution.

Professional sound engineers routinely employ sophisticated measurement systems and equalizers to optimize speakers to the installation. This has never been practical for the home audiophile. This is why R.A.B.O.S. was created. R.A.B.O.S. enables you to identify the dominant low-frequency response characteristic of your room. Once you know the problem, R.A.B.O.S. provides the tools needed to optimize the low-frequency characteristics of the speakers to the room they are in, exactly as the professional sound engineers do it.

## Performing R.A.B.O.S. Tests

These instructions assume you have already installed your Modulus subwoofer according to the information provided in the Owner's Guide. It is also assumed that all equipment in your entertainment system is interconnected properly and is in good operating condition.

## Preparations

Before beginning R.A.B.O.S. tests, please check the following:

- Make sure all three R.A.B.O.S. controls **11** **12** **13** on the Modulus subwoofer are turned fully clockwise.
- Set the R.A.B.O.S. On/Off Switch **10** to the "On" position.
- Make sure the loudness contour (if any) on your receiver/processor/preamp is turned off.
- Set the tone controls (Bass and Treble) to their center or flat positions.
- Bypass all surround and effects features of your receiver/processor/preamp or set to Stereo Bypass.
- If you are using a multichannel surround processor or receiver, make sure all bass-management features are properly set. The Audio channels should all be set to "Small" or "High-Pass" and the subwoofer set to "On."

You must have a CD player in the system. A CD player remote control is quite convenient but not essential.

For best results, it is recommended that all major furnishings are in place and that all doors and windows in the listening area are in their normal positions. That is, if you normally listen to music with all doors closed, then this is how they should be during this procedure.

Try to minimize ambient noise while running tests. Turn off all major appliances and any air conditioning or furnace fans. These can create significant subsonic noise that may be barely perceptible but which can wreak havoc on low-frequency measurements.

Critical information is highlighted with this mark: **!**

Helpful hints are marked with this symbol: **🔑**

## Contents of the R.A.B.O.S. Test CD

Track	Title	Track	Title
1	Welcome	32	Quick Retest 80Hz
2	Set System Test Level	33	Quick Retest 77Hz
3	Set Subwoofer Test Level	34	Quick Retest 72Hz
4	100Hz Test	35	Quick Retest 66Hz
5	95Hz Test	36	Quick Retest 63Hz
6	90Hz Test	37	Quick Retest 56Hz
7	85Hz Test	38	Quick Retest 52Hz
8	80Hz Test	39	Quick Retest 49Hz
9	77Hz Test	40	Quick Retest 46Hz
10	72Hz Test	41	Quick Retest 43Hz
11	66Hz Test	42	Quick Retest 40Hz
12	63Hz Test	43	Quick Retest 38Hz
13	56Hz Test	44	Quick Retest 35Hz
14	52Hz Test	45	Quick Retest 30Hz
15	49Hz Test	46	Quick Retest 26Hz
16	46Hz Test	47	Quick Retest 24Hz
17	43Hz Test	48	Quick Retest 22Hz
18	40Hz Test	49	Quick Retest 21Hz
19	38Hz Test	50	Quick Retest 20Hz
20	35Hz Test	51	Final System Level Adjustment
21	30Hz Test	52	Final Subwoofer Level Adjustment
22	26Hz Test	53	Wide Band Pink Noise, Left
23	24Hz Test	54	Wide Band Pink Noise, L+R
24	22Hz Test	55	Wide Band Pink Noise, Right
25	21Hz Test	56	Wide Band Pink Noise, L-R
26	20Hz Test	57	Wide Band Pink Noise, Uncorrelated
27	Intro to Quick Retest	58	1 to 4kHz Pink Noise, Left
28	Quick Retest 100Hz	59	1 to 4kHz Pink Noise, L+R
29	Quick Retest 95Hz	60	1 to 4kHz Pink Noise, Right
30	Quick Retest 90Hz	61	1 to 4kHz Pink Noise, Left-R
31	Quick Retest 85Hz	62	1 to 4kHz Pink Noise, Uncorrelated

Tracks 53–62 of the R.A.B.O.S. Test CD are test tones that can be used for general diagnostics of your system. They are not used for R.A.B.O.S. settings.

### The R.A.B.O.S. Sound-Level Meter (RSLM)

The RSLM is a battery-operated, handheld, acoustic measurement device specifically designed for Infinity R.A.B.O.S. On the face of the instrument is a light-emitting diode (LED) bar graph that indicates relative sound level. There are also indicators for power-on, out-of-range signals and a low battery.

R.A.B.O.S. Sound-Level Meter

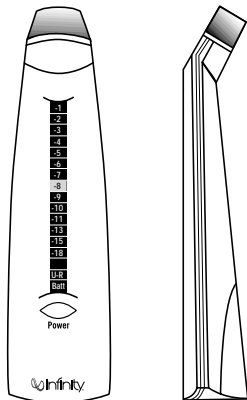

FIGURE 11

### RSLM bar-graph indications

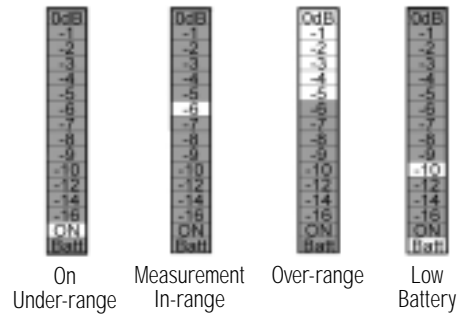

FIGURE 12

- **Power-On/Low Signal:** This is indicated by the illumination of any LED on the bar graph. If the sound level in the room is below the measurement range of the instrument, a green LED near the bottom of the bar graph will be illuminated.
- **Normal Measurements:** When the sound level is within the range of the RSLM, the green LED will be off and one of the red LEDs in the bar graph will be illuminated, indicating the relative sound level, in decibels (dB).
- **Over-Range:** If the sound level exceeds the range of the meter, 0dB through -5 will all light simultaneously.
- **Low Battery:** When the battery voltage is too low for accurate measurements, an LED at the bottom of the bar graph will be illuminated. Replace the battery.

ⓘ Do not attempt measurements when this light is on.

### RSLM Placement

Determine where in the room you are most likely to sit when listening to music or watching a movie. This is where you will want to hold the RSLM during measurements. The RSLM should be oriented so it can be easily read and held at your seated ear level during tests.

ⓘ You must use this same position for all tests.

🔗 The RSLM can be mounted on a standard camera tripod. This will ensure the best results.

## Initial System-Level Setting

The following steps will set the playback level of the system to the correct level for all tests that follow.

- 1 Turn the system volume to minimum.

Cue the R.A.B.O.S. Test CD to Track 2 and press **Pause II**. This track will produce band-limited pink noise in both the left and right channels.

Press **Play ▶**. With the RSLM positioned as described above, increase the system volume until the RSLM display indicates -10dB. See Figure 13.

RSLM indicating the correct system level to begin tests (-10dB)

When you have completed this adjustment, press **Pause II**.



FIGURE 13

## Setting the Subwoofer Test Level

⌚ Each of the following test tracks is about one minute long. This is normally much longer than required. Press **Pause II** or advance to the next test as soon as you are ready.

This step will set the subwoofer level for measurement purposes. The objective is to scale the subwoofer's output to make full use of the RSLM indicator range. Scaling is optimum when a 0dB reading is observed on the highest peak without triggering the over-range indication. Later, you will rebalance the subwoofer to the main speakers.

- 1 The Modulus subwoofer should be shipped with the three R.A.B.O.S. controls, 11, 12 and 13, set to fully clockwise positions, and all measurements should be conducted with their level controls in this position. Confirm this setting before you begin this test. The Gain Control 9 should be set to the mid position (5).

Cue Track 3 and **Pause II**. Track 3 continuously steps through all subwoofer test tones for approximately 1 minute. Each tone will play just long enough for the RSLM to give a stable reading.

⌚ To get accurate measurements, it is necessary to play the woofers quite loud. The 0dB indication is about 94dB. At this level, frequencies below 100Hz can cause doors, windows, furnishings and other objects in the room to vibrate. This frequently results in clearly audible buzzes and/or rattles that come and go as each test tone plays. Strong buzzes not only sound bad, they can cause measurement errors. If you hear a buzz or rattle during this test, it is highly recommended that you

locate the source and eliminate its effects. This is actually a valuable room-diagnostic tool.

Press **Play ▶**. As Track 3 plays, watch the RSLM carefully. Watch for peak readings. The peak reading may be no more than a brief flash. Readjust the subwoofer's Gain Control 9 until the peak level observed is 0dB without triggering the over-range indication. See Figure 14.

### Adjusting the subwoofer levels for a 0dB peak

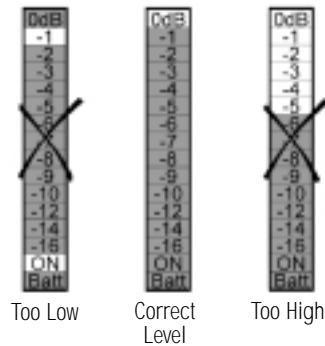

FIGURE 14

When finished, press **Pause II**.

## Performing Low-Frequency Measurements

⌚ Read the following instructions fully before beginning tests.

For the following steps, you will need a Measurement Template and a pencil.

FIGURE 15

### R.A.B.O.S. Measurement Template

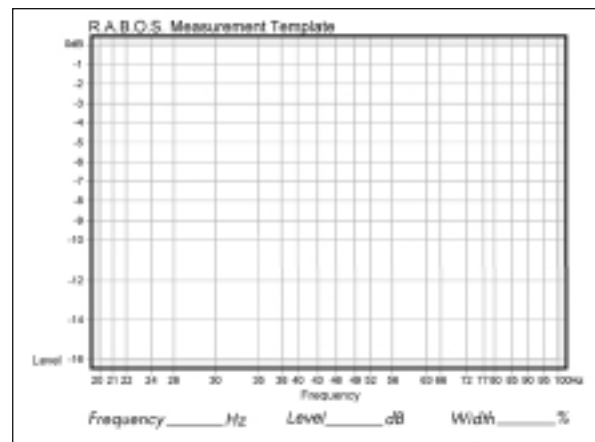



Each of the following tracks produces a low-frequency test tone. The range of these tests is from 100Hz down to 20Hz. The frequency of each test is announced before it begins. The first test is the highest frequency (100Hz); therefore, you will be marking the template from right to left. Each frequency point is listed across the bottom of the Measurement Template (this is called the X-axis). See Figure 15 on the previous page. The vertical scale on the left side of the template indicates relative level, in dBs (the Y-axis). The template's vertical scale matches that of the RSLM bar graph.

Cue Track 4 and **Pause II**.

☞ From now on, you will want to keep your CD player's remote control handy.

Press **Play** ▶. As Track 4 plays, observe the level indicated on the RSLM.

EXAMPLE: The test frequency is 100Hz and the level indicated is -2dB. Find the intersection of 100Hz (X-axis) and -2dB (Y-axis). Place a dot at that point. See Figure 16.

#### Locating a test point

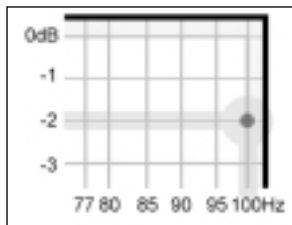

FIGURE 16

☞ It takes a few seconds for the RSLM reading to stabilize, especially at very low frequencies. Don't rush. Give each test adequate time for the meter to stabilize.

At the bottom of the bar graph is a green "ON" LED. This LED is illuminated whenever the sound level is below the measuring range of the RSLM. If this occurs during a test, place a dot at the intersection of the test frequency and the bottom frame of the template. See Figure 17.

#### Indicating an under-range test

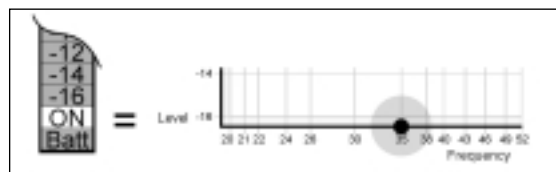

FIGURE 17

When finished, press **Skip** ▶▶ to advance to the next test. Repeat the process described above for Tracks 5 through 26.

When you have completed the 23 measurements, you are ready to analyze the data and make corrective adjustments. The completed Measurement template will look something like the example in Figure 18.

#### Completed R.A.B.O.S. template

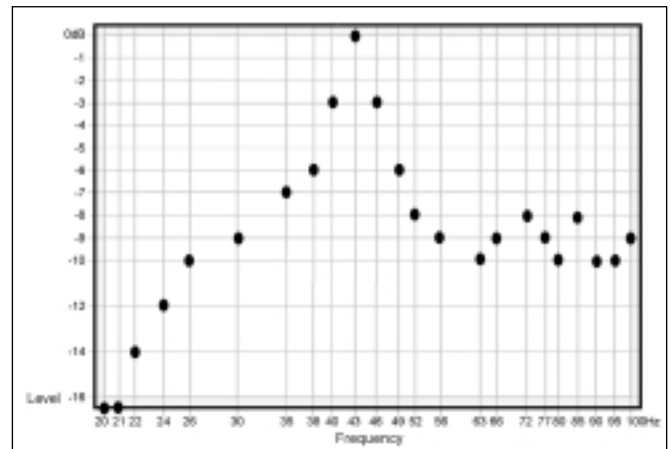

FIGURE 18

Now connect the dots as shown in Figure 19. This will make interpretation of the data much easier.

#### Test example with dots connected

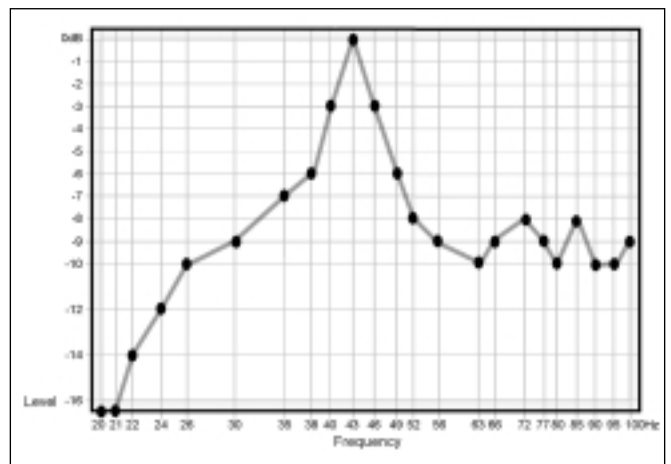

FIGURE 19

## R.A.B.O.S. Online

Now that you have obtained the data necessary to make final adjustments, a few more calculations are required to determine the ideal position of the three bass optimization controls. These calculations are covered in detail, and are available for your reference in the remaining pages of this owner's guide. It is recommended that you read through to get a better understanding of the functions and benefits of R.A.B.O.S. However, if you have access to the Internet, you may choose to skip to "Adjusting the R.A.B.O.S. Equalizer" on page 19, and have your settings calculated by Infinity's online R.A.B.O.S. calculator. You can find this in the "Owner Info" section of our Web site at [www.infinitysystems.com](http://www.infinitysystems.com).

## What Does a Parametric Equalizer Do?

The R.A.B.O.S. system uses one band of parametric equalization for response correction. Parametric equalizers are the most versatile class of filters. The effect an equalizer will have on the signal is dependent on three parameters.

**Frequency:** The equalizer will have maximum effect at one frequency, usually described as the center frequency.

**Level:** This refers to the amount of cut (in dBs) the equalizer is set for.

**Bandwidth:** Defines the range of frequencies over which the equalizer will have an effect. On the Modulus subwoofer, this adjustment is abbreviated as "Width."

Only parametric equalizers allow independent adjustment of all three parameters.

These will be explained more fully in the sections that follow.

## Completing the Measurement Template

Along the bottom of the Measurement Template are three fields where you will enter the equalizer settings needed to complete system optimization.

These instructions are based on the example in Figure 19. Use this tutorial to become familiar with the process. Strategies for several other test results will be presented later. After you have completed these three entry fields, you will be ready to perform the adjustments, completing R.A.B.O.S. optimization.

### Frequency

The frequency of the R.A.B.O.S. equalizer may be adjusted to any one of nineteen frequencies from 20Hz to 80Hz. This defines where you are going to apply equalization.

## Effect of adjustable width

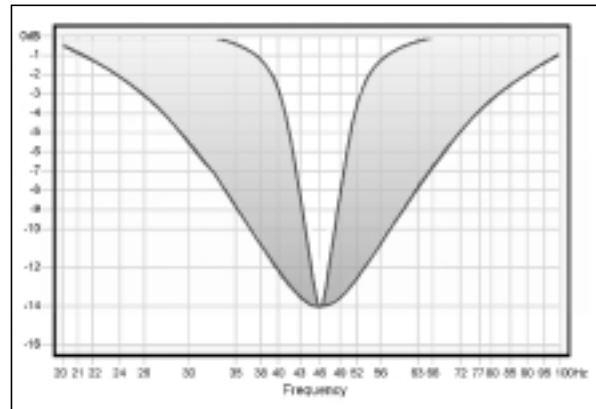

FIGURE 20

### Width

The frequency range of the R.A.B.O.S. equalizer may be set from 5% to 50% of an octave in 21 steps. This setting defines how much of the subwoofer's output will be equalized.

Width is expressed as a percentage of an octave. For example, a width setting of 25% means the equalizer will affect a frequency band of 1/4 of an octave; 1/8 of an octave above and 1/8 of an octave below the center frequency.

➔ The octave is a logarithmic expression. From any point in the spectrum, one octave above or below that point is always double or half the frequency. Therefore, one octave above 100Hz would be 200Hz. One octave below 100Hz is 50Hz.

In the section that follows, we will discuss the use of the Width Selector.

## Using the Width Selector

① Read the following instructions carefully. The example presented may not look like the graph you just created. Focus on the concepts and techniques presented. Specific cases will be discussed later.

### Width Selector

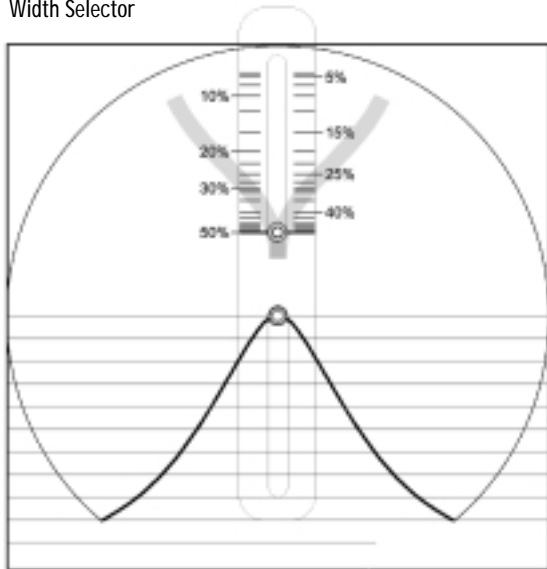

FIGURE 21

You will use the Measurement Template just completed and the Width Selector to determine the correct width setting. The Width Selector graphically depicts a single resonant peak. The peak looks similar to a slice of a pie. See Figure 21. At the top of the Selector is a pull tab. When you slide the tab up and down, the width of the pie slice becomes narrower and wider, respectively. The pointers on the sides of the button point to the bandwidth that corresponds to the width of the slice.

Place the Width Selector over the Measurement Template, positioning the center rivet of the Selector over the response peak, as shown in Figure 22. Be sure to align the horizontal lines of the Width Selector with those of the Measurement Template.

### Placement of the Bandwidth Selector

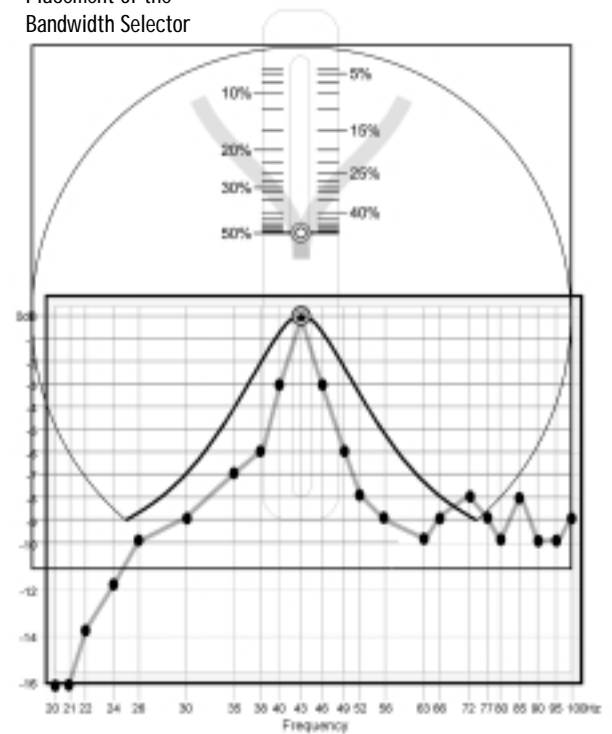

FIGURE 22

Apply pressure to the upper and lower left corners of the Selector using the thumb and forefinger of your left hand. Now gently slide the tab up or down until the adjustable slice most closely fits the response data. See Figure 23.

### Selector adjusted for the "best fit"

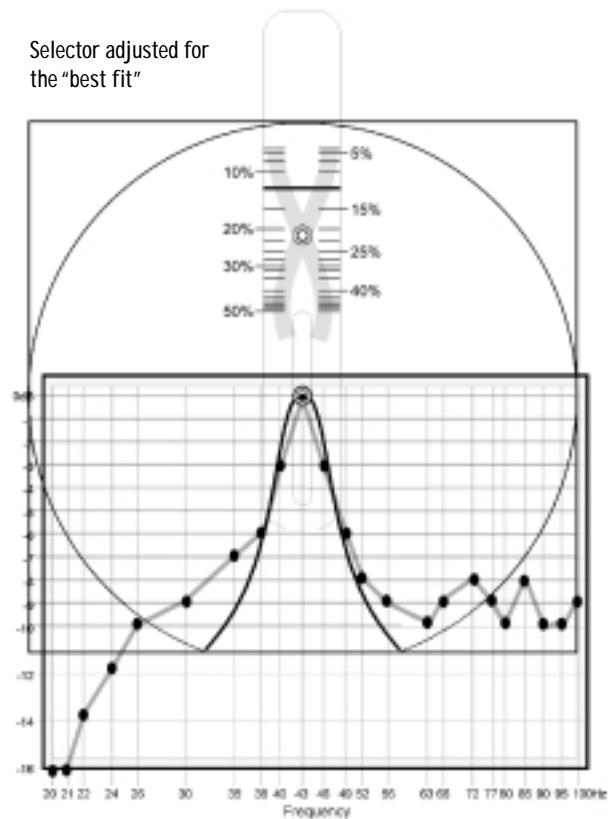

FIGURE 23

The pointer on the slider will indicate the correct width setting. Enter this number in the Width field of the Measurement Template. In our example, the width is 12.5%.

It is not realistic to expect a perfect fit. Acoustic measurements encompass the behavior of not only the speakers but of the room and its contents as well. Reflected energy, standing waves and ambient noise all add their part. Determining the best width setting nearly always requires compromise.

### Level

This setting will define the amount (level) you want to reduce the peak, in decibels.

The R.A.B.O.S. level adjustment is limited to attenuation only, and is adjustable from 0dB to -14dB. After optimization, the R.A.B.O.S. equalizer will eliminate the largest low-frequency peak; therefore, the broadband bass level can be increased without overpowering the midrange frequencies. R.A.B.O.S. applies this compensation automatically.

You will use the Width Selector as an aid in determining the correct level setting. Place the Width Selector as described above and adjust it to the correct width. Observe the first frequency point on the high-frequency side of the peak that no longer follows the slope of the Width Selector. In this example this is 56Hz. Calculate the average level of the readings from 56Hz up to 100Hz; that is, 10 data points in this example.

56Hz	63Hz	66Hz	72Hz	77Hz	80Hz	85Hz	90Hz	95Hz	100Hz
-9	-10	-8	-9	-10	-9	-8	-10	-10	-9

$-92 \div 10 = -9.2$

Whenever your answer has a remainder, always round down (disregarding the negative [-]) to the next whole number.

In our example, you would enter 9 in the attenuation field.

This may not be the best method in all cases. The next section contains several other examples.

### What You Measure, What To Do

As stated earlier, it is not possible to anticipate the effect of every possible listening environment. However, most residential sound rooms share many characteristics, and their dimensions fall into a range that makes some response irregularities far more likely than others. On the following pages are examples of what you may encounter. Following each example is a strategy for correction. Compare your measurement results with the following examples. Find the one that best fits your graph and follow the instructions presented for that scenario.

Remember, when looking for a match, look at the descriptive characteristics, not any specific frequency or level. Each of these examples can occur at any frequency, bandwidth and level. It is unlikely that your test results will be exactly as depicted in these examples.

### Example 1. Single Dominant Peak:

#### Single dominant peak

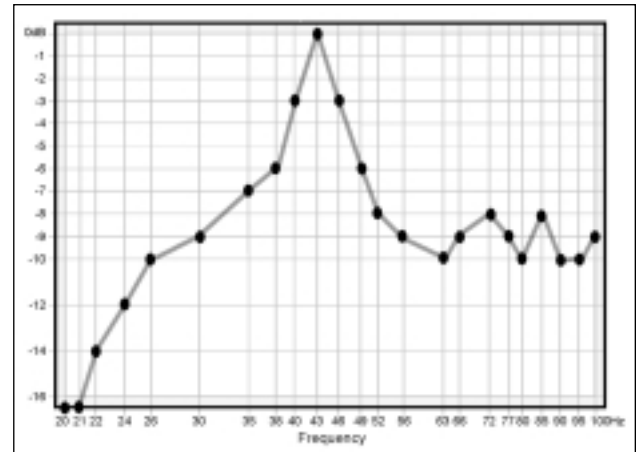

FIGURE 24

This is the most common result of speaker/room interaction.

Apply the Width Selector as demonstrated in Figure 22. Align the center line of the Selector over the center of the peak, as shown in Figure 22. Now adjust the Selector until you have achieved the “best fit.” The slider now points to the correct bandwidth setting. In this example, the frequency is 43Hz and the best-fit width is 12.5%. Fill in the Width and Frequency fields provided on the template.

Determine the appropriate level using the technique described earlier. In this example, -9dB would be best. Enter the level in the field provided.

Skip to the “Adjusting the R.A.B.O.S. Equalizer” section on page 19.

Example 2. Two Response Peaks:

Two response peaks

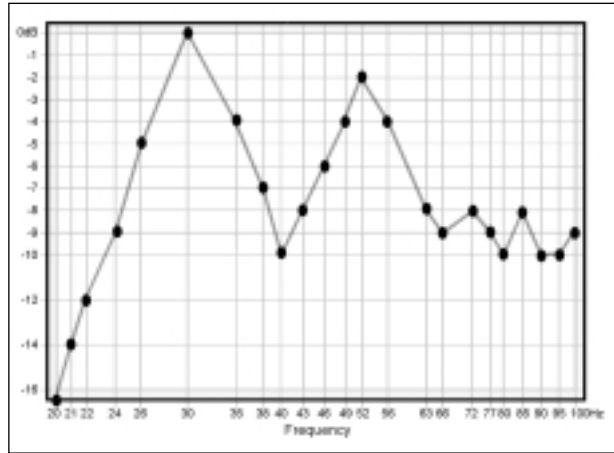

FIGURE 25

Characterized by two response peaks, approximately equal in amplitude and width. This requires that you make a choice between the two peaks. In situations like this, the higher frequency peak will always be more audible and objectionable. Response peaks below 45Hz, unless extreme, can actually be beneficial toward achieving visceral impact. Perform corrections on the upper frequency peak.

Apply the Width Selector as described above. Align the center line of the Selector over the center of the higher frequency peak. Now adjust the Selector until you have achieved the "best fit." The slider now points to the correct width setting. In this example, this is at 52Hz. The best-fit width is 28%. Fill in the Width and Frequency fields provided on the template.

Determine the appropriate level using the technique described earlier. This calculation will indicate a -8dB setting. However, this peak does not reach the 0dB level as the lower peak does. Therefore, a -8dB setting would be excessive. The 52Hz peak stops at -2dB. Subtracting 2 from 8 yields the correct setting, -6dB. Enter -6 in the Level field.

Skip to the "Adjusting the R.A.B.O.S. Equalizer" section on page 19.

Example 3. Peak Adjacent to a Dip:

Dip above or below peak

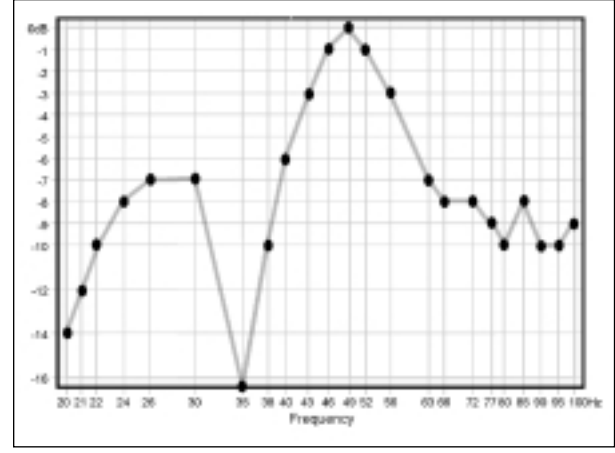
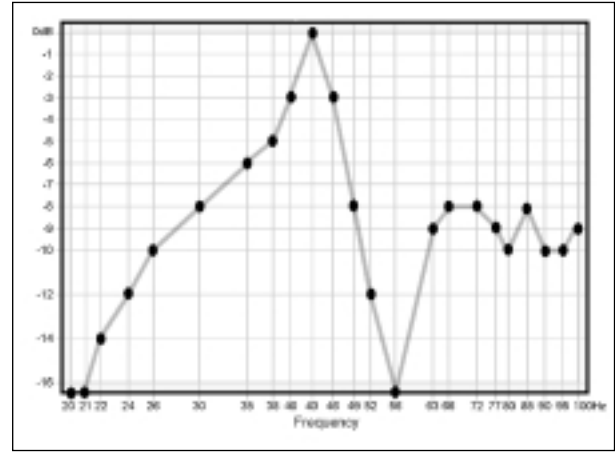

FIGURE 26

Response dips can occur at any frequency, sometimes immediately adjacent to the peak you want to correct. Two examples are shown, one immediately above and one immediately below the peak. Deep response dips such as these are caused by destructive wave interference. Destructive interference dips occur only in one spot within the room. It is not uncommon to completely eliminate the effect by moving the RSLM to a different location. Note that this does not eliminate the dips. We have simply moved away from them. Sometimes only a few inches are required. Do not attempt to correct this condition with equalization. If you encounter dips like this, take the following steps:

1. Select a new test position: Cue the test track corresponding to the center frequency of the dip. In the first example in Figure 24, you would play Track 13 (56Hz). Press **Play** ►. You will see a reading very close to what you had before. Now, slowly move the RSLM around the area, if possible remaining within about a foot of the original test point. As you move the RSLM, watch the bar graph. You will observe large level fluctuations. Find a position that restores the level to approximately that of the adjacent test points. You may find it helpful to move the RSLM vertically. Dips can be oriented in any axis. The position that restores the level to about that of the adjacent test points is your new test position.

2. Reset the test level: Return to the section “Setting the Subwoofer Test Level” on page 12. Perform the procedure as described.

3. Repeat the measurements: Now that you are familiar with the measurement process, you can go much faster by using Tracks 27–50. These tracks contain all the test tones necessary for measurement. However, each test is only about three seconds, and there is no frequency announcement. The first test is 100Hz. Just place each test mark in order until finished. Connect the dots.

Your second measurement will no longer exhibit the deep response dip. However, the peak will still be evident. Without the influence of the response dip, the amplitude and center of the peak may have changed. Compare your new data to the examples given in this section of the manual. Follow the instructions for the example that most closely matches your new measurement.

**Example 4. Narrow Response:**

**Narrow Response**

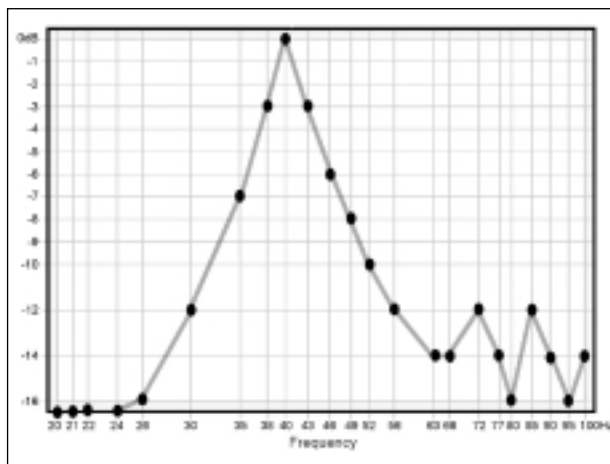

**FIGURE 27**

Although it looks as though this speaker is quite bass-deficient, this is actually indicative of a single, very narrow peak in excess of 10dB high.

Apply the Width Selector as described above. Align the center line of the Selector over the center of the peak, as shown in Figure 22. Now adjust the Selector until you have achieved the “best fit”. The slider now points to the correct width setting. In this example, the frequency is 40Hz and the best-fit width is 10%. Fill in the Width and Frequency fields provided on the template.

Determine the appropriate level using the technique described earlier. In this example, -13dB is indicated. Enter 13 in the field provided.

Skip to the “Adjusting the R.A.B.O.S. Equalizer” section on page 19.

**Example 5. One or More Narrow Dips:**

**Example of two narrow dips**

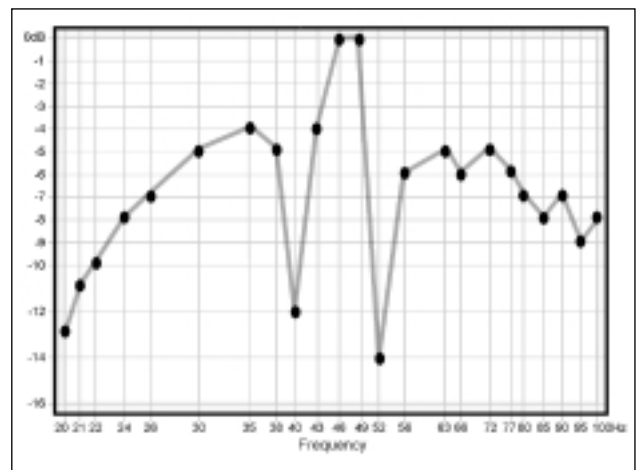

**FIGURE 28**

Response dips can occur at any frequency, sometimes immediately adjacent to the peak you want to correct. In this example, there are two such dips on either side of the peak. Deep response dips such as these are caused by destructive wave interference. Destructive interference dips occur only in one spot within the room. It is not uncommon to completely eliminate their effect by moving the RSLM to a different location. Note that this does not eliminate the dips. We have simply moved away from them. Sometimes only a few inches are required. Do not attempt to correct this condition with equalization. If you encounter dips like this, take the following steps:

1. Select a new test position: Cue the test track corresponding to the center frequency of the dip. In the example in Figure 28 you would play Tracks 14 (52Hz) and 18 (40Hz). Press **Play** ▶. You will see a reading very close to what you had before. Now, slowly move the RSLM around the area, if possible remaining within about a foot of the original test point. As you move the RSLM, watch the bar graph. You will observe large level fluctuations. Find a location for the subwoofer or a test location that raises the response at these frequencies. You may find it helpful to move the RSLM vertically. Dips can be oriented in any axis. The position that restores the level to about that of the adjacent test points is your new test position.

2. Reset the test level: Return to the section "Setting the Subwoofer Test Level" on page 12. Perform the procedure as described.

3. Repeat the measurements: Now that you are familiar with the measurement process, you can go much faster by using Tracks 27–50. These tracks contain all the test tones necessary for measurement. However, each test is only about three seconds, and there is no frequency announcement. The first test is 100Hz. Just place each test mark in order until finished. Connect the dots.

Your second measurement will no longer exhibit the deep response dips. However, the peak will still be evident. Without the influence of the response dips, the amplitude and center of the peak may have changed.

4. Interpret the new data: Compare your new data to the examples given in this section of the manual. Follow the instructions for the example that most closely matches your new measurement.

**Example 6. Ideal Response:**

**Ideal response, no EQ needed**

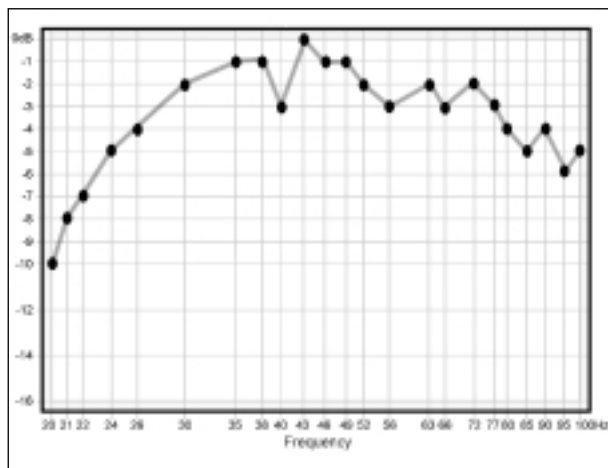

**FIGURE 29**

If your test data looks similar to the example in Figure 29, you have a very favorable setup. Skip to the "Final System Balance" section, page 20.

### Adjusting the R.A.B.O.S. Equalizer

Now that you have performed the measurements and interpreted the data, you have the information needed to adjust the subwoofer's equalizer.

There is a R.A.B.O.S. On/Off Switch **10** located in the top right corner of the Modulus subwoofer's rear. This switch must be set to the "On" position in order for the equalizer controls to take effect. You can defeat all equalizer controls by setting the switch to the "Off" position.

There are three equalizer adjustments on the Modulus subwoofer. Top to bottom, they are marked "Freq," "Level" and "Width." Each control has 21 positions. These are numbered from left to right. Therefore, Position 1 is the full counterclockwise position. The following table illustrates all switch positions.

Position	F (Hz)	L (dB)	W
1 CCW	20	-14.1	4.5%
2	20	-13.9	5%
3	20	-13.5	7.5%
4	21	-13.1	10%
5	22	-12.7	12.5%
6	24	-11.7	16.5%
7	26	-11.0	20.5%
8	30	-10.2	23%
9	35	-9.5	26%
10	38	-8.9	28%
11	40	-8.3	29.5%
12	43	-7.9	31%
13	46	-6.4	34%
14	49	-4.4	39%
15	52	-2.9	41.5%
16	56	-1.9	43.5%
17	63	-1.1	45%
18	66	-0.5	46.5%
19	72	0.0	48%
20	77	0.0	49%
21 CW	80	0.0	49.5%

## MAINTENANCE AND SERVICE

You must use the R.A.B.O.S. key to adjust these controls. Using the adjustment key, adjust the controls as indicated by the Measurement Template. Each value shown in the table is represented by detents in the R.A.B.O.S. controls. Simply count the number of detents necessary, indicated by the results of your R.A.B.O.S. Test.

After performing these adjustments, you may skip forward to the "Final System Balance" section. It is recommended that you perform a second measurement to confirm that the settings are correct.

❶ If you are going to retest the system after EQ adjustments, repeat the "Setting the Subwoofer Test Level" section on p. 12.

🔗 Retesting the system will go much faster if you use Tracks 27–50. These tracks contain all the same test tones you just used. However, each tone plays for only a few seconds and there is no frequency announcement. If you are uncomfortable operating at this pace, you may, of course, perform measurements with the original test tracks.

Your first interpretation of the data and choice of settings may not be optimum. You can repeat the test-adjust-test cycle as often as needed to get the desired results. To do this, return to page 12, "Setting the Subwoofer Test Level." You may prefer to retest using the same template. Doing so makes it easy to evaluate the improvement.

When you are satisfied with the results, go to "Final System Balance."

### Final System Balance

Cue Track 51 of the R.A.B.O.S. Test CD. Press Play ►. Increase the system volume until the RSLM indicates -10dB. Now play Track 52. Adjust the subwoofer gain control until -10dB is indicated on the RSLM. Of course, you may fine-tune the subwoofer gain control to your listening preference.

This concludes the R.A.B.O.S. process. It is recommended that you remove the battery from the RSLM. Store the Test CD, Width Selector, Adjustment Key and the RSLM together.

The satellite and subwoofer enclosures may be cleaned using a soft cloth, dampened with water only, to remove fingerprints or to wipe off dust.

The grilles may be gently vacuumed. Stains may be removed with an aerosol cleaner, following its instructions. Do not use any solvents on the grille.

All wiring connections should be inspected and cleaned or remade periodically. The frequency of maintenance depends on the metals involved in the connections, atmospheric conditions, and other factors, but once per year is the minimum.

If a problem occurs, make sure that all connections are properly made and clean. If a problem exists in one loudspeaker, reverse the connection wires to the left and right system. If the problem remains in the same speaker, then the fault is with the loudspeaker. If the problem appears in the opposite speaker, the cause is in another component or cable. In the event that your Modulus loudspeaker system ever needs service, contact your local Infinity dealer or Infinity directly at 1-800-553-3332 or [www.infinitysystems.com](http://www.infinitysystems.com) for a service center near you.



# SPECIFICATIONS

## Modulus Home-Theater System

	<b>Satellite</b>	<b>Center Channel</b>
<b>Frequency Range:</b>	100Hz – 20,000Hz (±3dB)	80Hz – 20,000Hz (±3dB)
<b>Recommended Amplifier Power Range:</b>	15 – 125 watts	15 – 125 watts
<b>Sensitivity:</b> (2.83V @ 1 meter)	86dB	88dB
<b>Nominal Impedance:</b>	8Ω	8Ω
<b>Crossover Frequency:</b>	2500Hz, 12dB/Octave	2500Hz, 12dB/Octave
<b>Midrange Driver(s):</b>	4" C.M.M.D., magnetically shielded	Dual 4" C.M.M.D., magnetically shielded
<b>High-Frequency Driver:</b>	3/4" C.M.M.D., magnetically shielded	3/4" C.M.M.D., magnetically shielded
<b>Dimensions (H x W x D):</b>	<b>Shelf position</b> 11" x 5-1/2" x 4-1/2" (279mm x 140mm x 114mm) <b>Wall position</b> 9-3/4" x 5-1/2" x 5-3/4" (248mm x 140mm x 146mm)	6-1/4" x 20-3/4" x 4-1/2" (159mm x 527mm x 114mm)
<b>Weight:</b>	5.1 lb (2.3kg)	8.3 lb (3.8kg)

## Powered Subwoofer

<b>Frequency Range:</b>	27Hz – 100Hz (±3dB)
<b>Amplifier Output:</b>	300 watts RMS, 600 watts Peak
<b>Low-Frequency Driver:</b>	12" C.M.M.D., magnetically shielded
<b>Crossover Frequency:</b>	100Hz, 12dB/Octave
<b>Dimensions (H x W x D):</b>	16-1/2" x 14-1/2" x 19-1/4" (419mm x 368mm x 489mm)
<b>Weight:</b>	42 lb (19.1kg)

Infinity continually strives to update and improve existing products, as well as create new ones. The specifications and construction details in this and related Infinity publications are therefore subject to change without notice.

R.A.B.O.S. Measurement Template

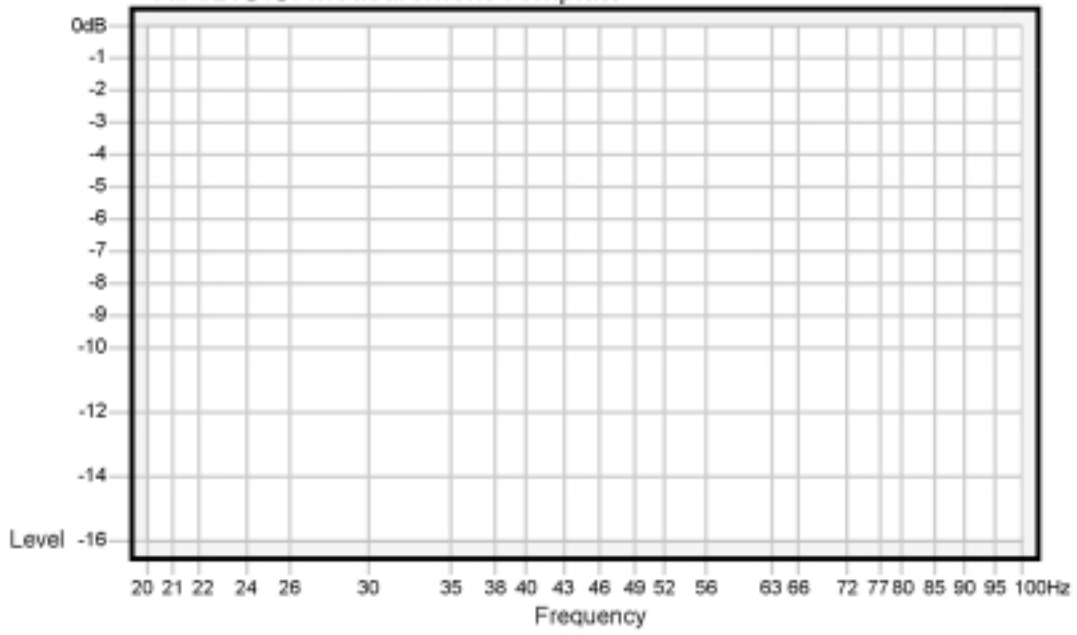

Frequency \_\_\_\_\_ Hz      Level \_\_\_\_\_ dB      Width \_\_\_\_\_ %

R.A.B.O.S. Measurement Template

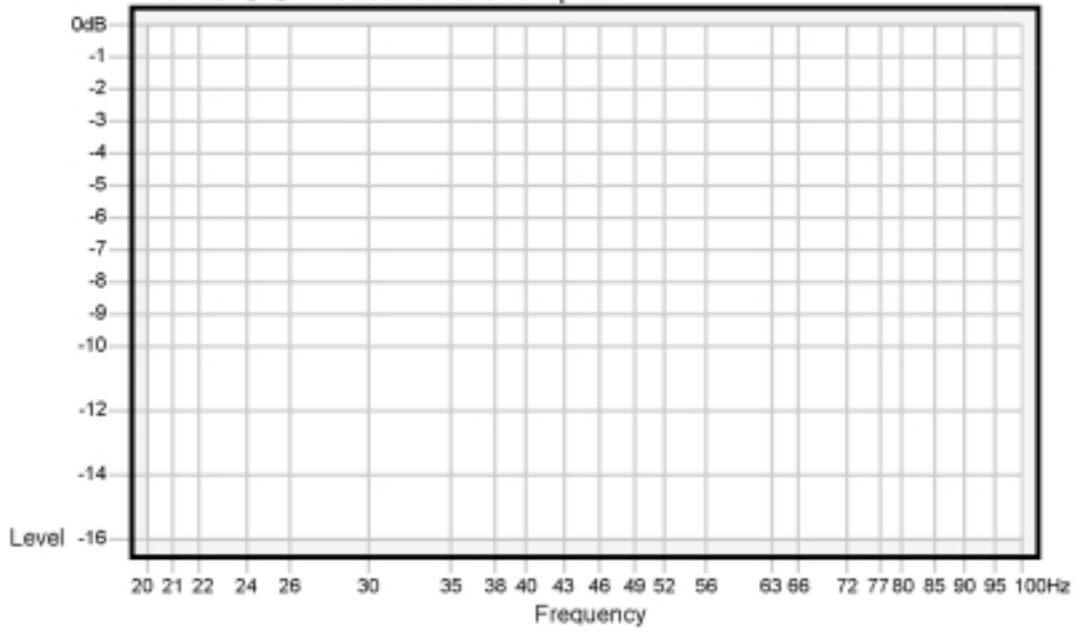

Frequency \_\_\_\_\_ Hz      Level \_\_\_\_\_ dB      Width \_\_\_\_\_ %

R.A.B.O.S. Measurement Template

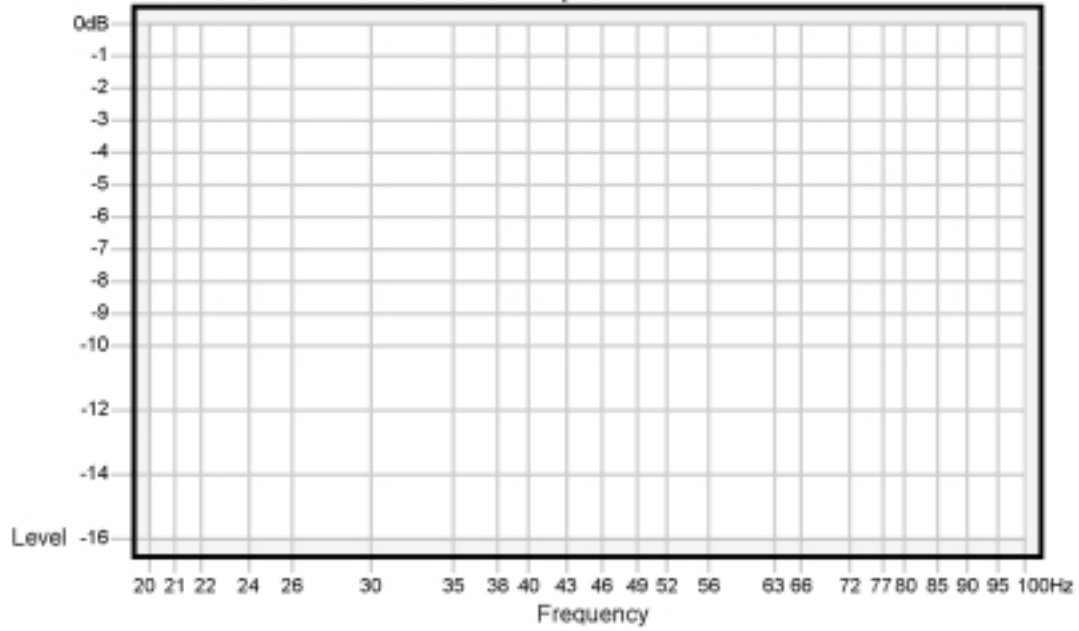

Frequency \_\_\_\_\_ Hz      Level \_\_\_\_\_ dB      Width \_\_\_\_\_ %

R.A.B.O.S. Measurement Template

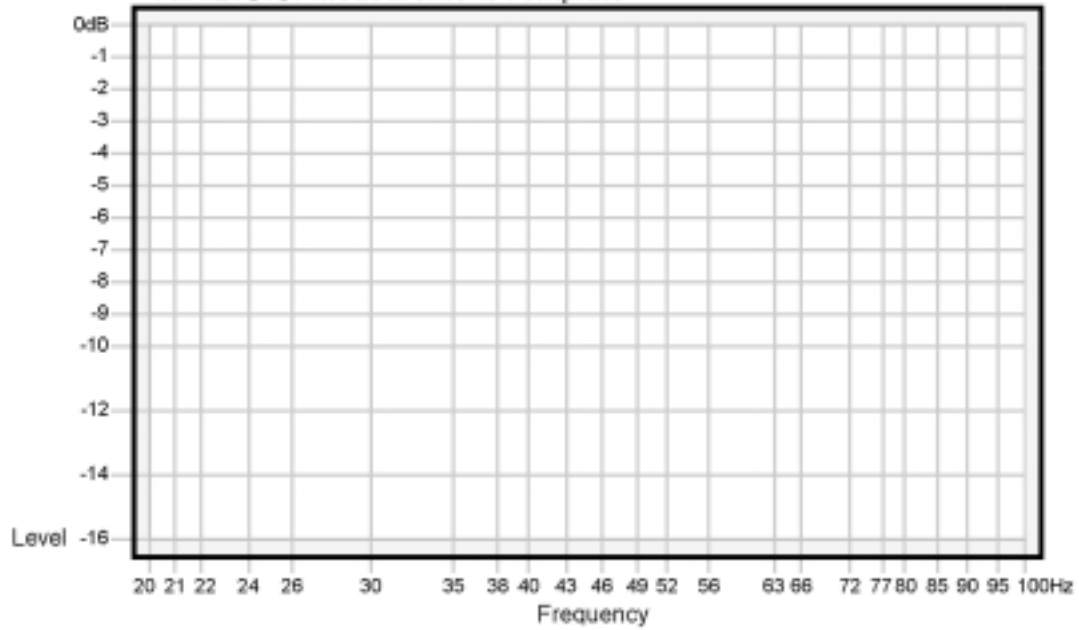

Frequency \_\_\_\_\_ Hz      Level \_\_\_\_\_ dB      Width \_\_\_\_\_ %



**HA Harman International Company** © 2001 Infinity Systems, Inc., 250 Crossways Park Drive, Woodbury, NY 11797 USA (800) 553-3332 (USA Only) [www.infinitysystems.com](http://www.infinitysystems.com)

\*Trademarks of Dolby Laboratories. BASH is a registered trademark of Indigo Corporation. DTS is a registered trademark of Digital Theater Systems, Inc.

Infinity is a registered trademark of Infinity Systems, Inc. Printed in USA 4/01 Part No. 336782-001